

### H-Bridge 1v0 B. Altvater 2014

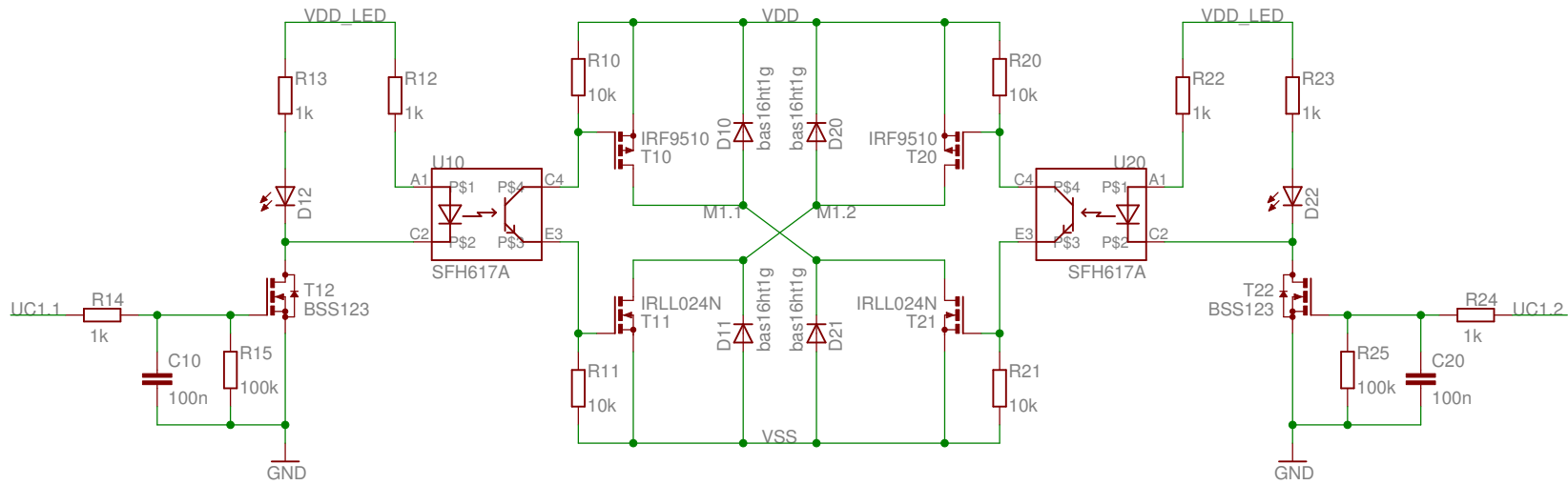

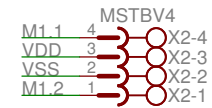

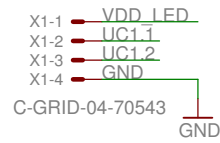

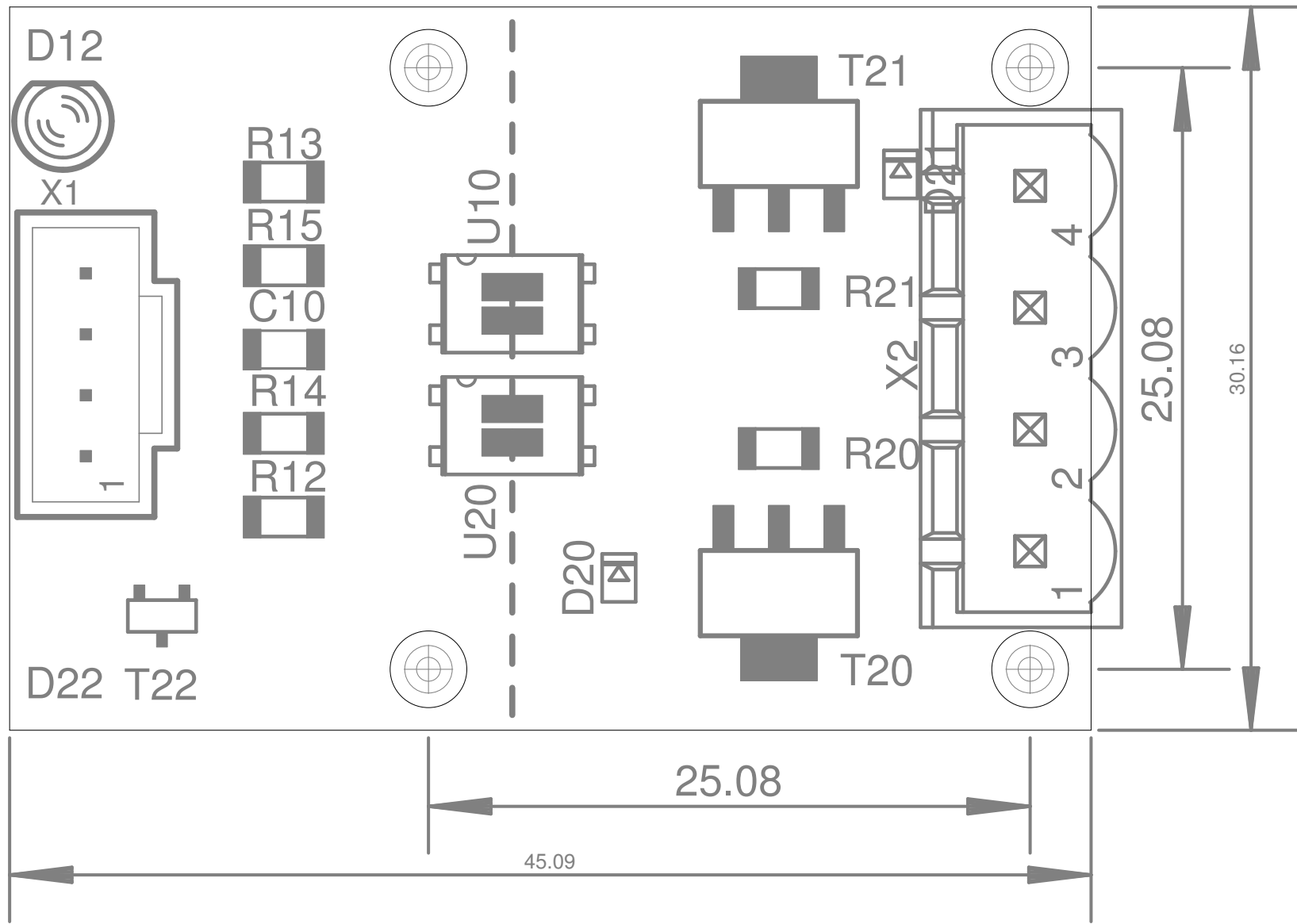
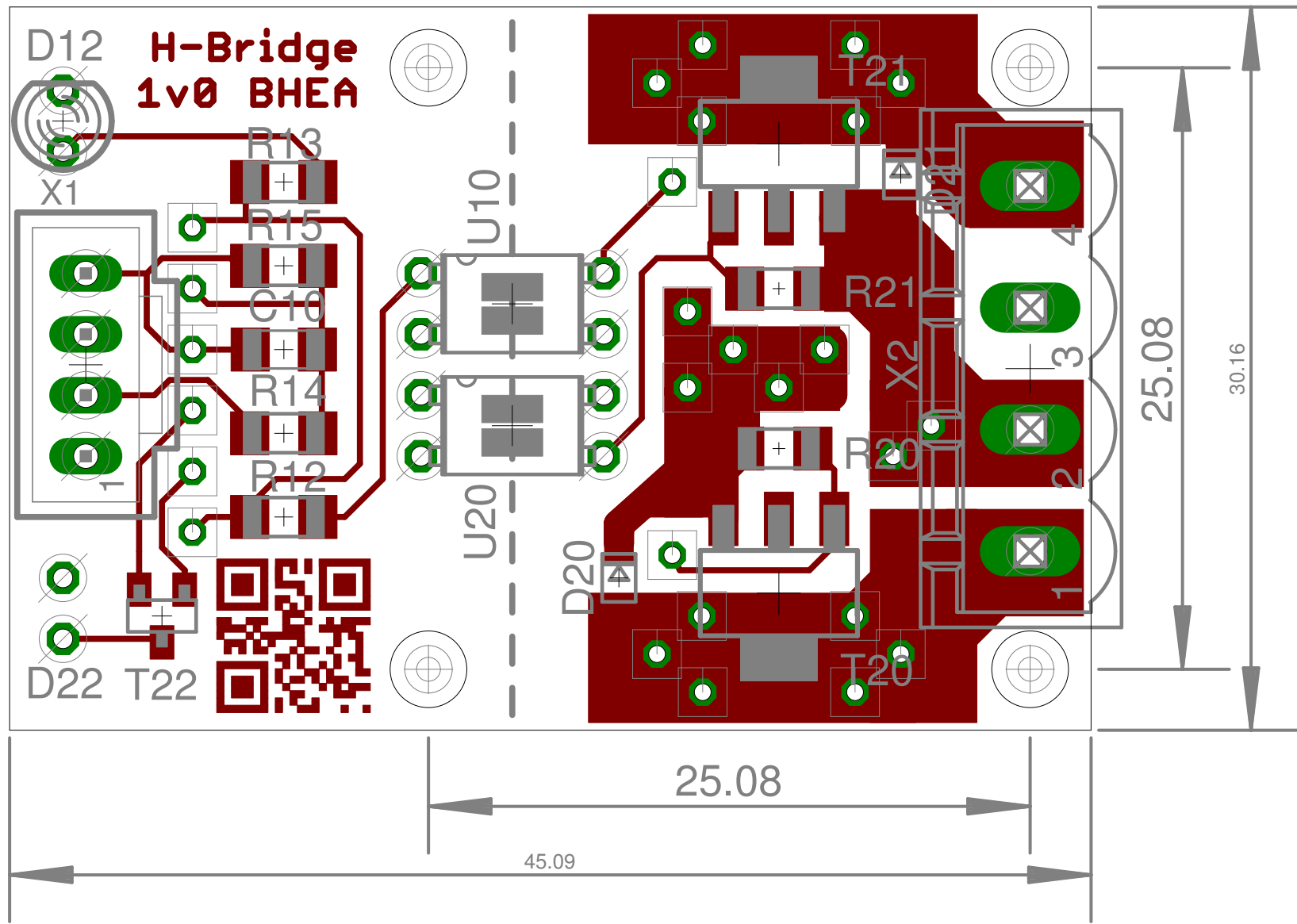
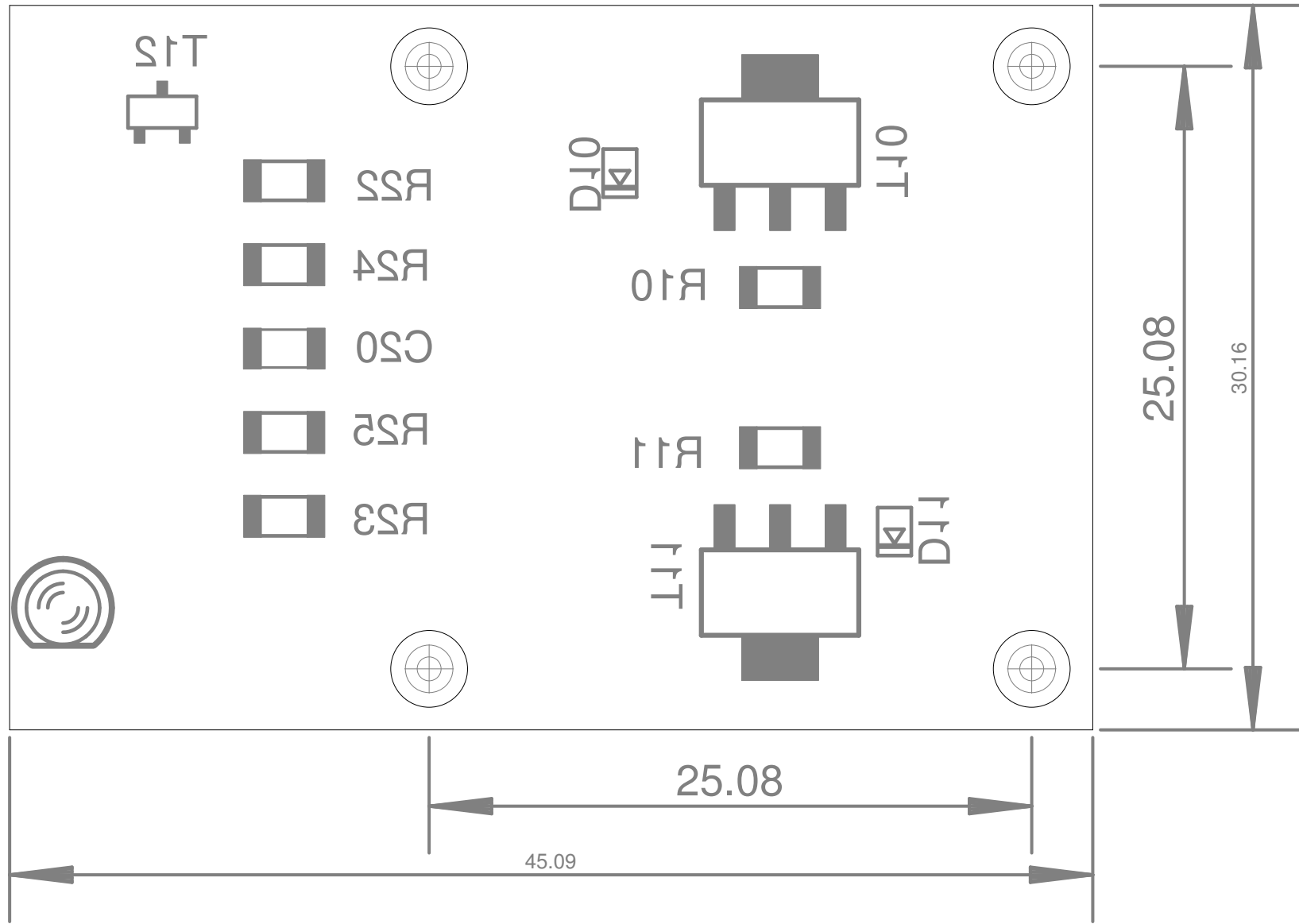

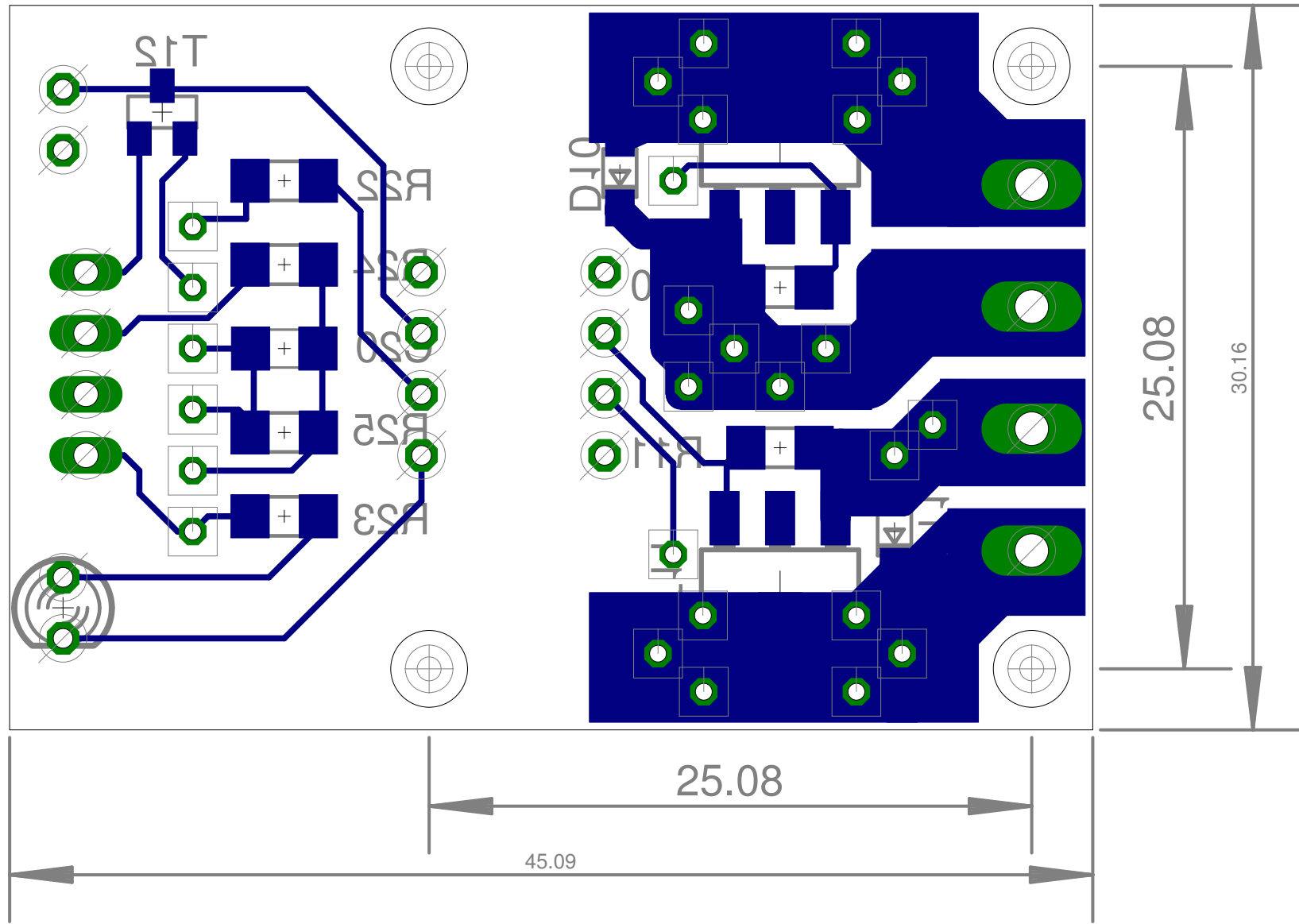

Partlist exported from /mnt/hgfs/Eagle-Projects/001-HBridge/CNC\_PCB\_HBridge-1v0.sch at 8/3/14 6:49 PM

Qty	Value	Device	Package	Parts	Description
MF	MPN	OC_FARNELL	OC_NEWARK		
2		LED3MM	LED3MM	D12, D22	LED
2112100					
2	100k	RESISTOR_R-EU_R1206	RESISTOR_R1206	R15, R25	RESISTOR, European symbol
2008320					
2	100n	C-EUC1206	C1206	C10, C20	CAPACITOR, European symbol
499389					
4	10k	RESISTOR_R-EU_R1206	RESISTOR_R1206	R10, R11, R20, R21	RESISTOR, European symbol
1840657					
6	1k	RESISTOR_R-EU_R1206	RESISTOR_R1206	R12, R13, R14, R22, R23, R24	RESISTOR, European symbol
2008393					
2	BSS123	BSS123	SOT23	T12, T22	N-CHANNEL MOS FET
9845321					
1	C-GRID-04-70543	C-GRID-04-70543	70543-04	X1	CONNECTOR
2396253					
2	IRF9510	IRF9510SOT-223	SOT-223	T10, T20	
1298489					
2	IRLL024N	IRLL024N	SOT-223	T11, T21	
8651205					
1	MSTBV4	MSTBV4	MSTBV4	X2	
1624302					
2	SFH617A	CNC_PCB_SFH617A	CNC_PCB_DIP-4	U10, U20	
1469580					
4	bas16ht1g	D-	SOD323-W	D10, D11, D20, D21	DIODE
1621821					